

March[®] Rifle Scope

Second Focal Plane Reticle Scope

Owner's Manual
(English Language Edition)



*Thank you for purchasing your March Rifle Scope.
Please read this owner's manual thoroughly before
using your scope.*

WARNING:

Never use a telescope to look at the Sun.

Using a rifle scope to look at the Sun will cause permanent and irreversible eye damage.

Make sure that you set enough eye relief position of your scope to prevent injury from recoil. Setting your new scope with incorrect eye relief and improper mounting can cause physical damage to the shooter.

Before you mount your new March Scope

Your new March scope has come out of the factory but will need to be set up for your eyes. Before you begin using your March scope, you will need to take a moment to level the scope's reticle, focus the reticle for your eyes and bore sight your rifle.

Leveling the reticle for your new March scope is covered on Page 4. Taking the time to do this as you set up your new scope is important to avoid canting and long range shooting errors.

The best way to focus your March scope's reticle is covered on Page 4. This can either be done before or after the scope is mounted on your rifle.

Bore sighting your March scope is covered in more detail on Page 5. Making sure the rings and bases are perfectly aligned before setting up your new scope will help to remove possible sighting errors by eliminating structural pressure on your new scope. It will also keep your March scope as close to its optical center as possible.

Adjusting your new March scope to the extremes of the elevation or windage dials prevents you from sighting through the central axis of the scope. This means you will see the target through the outer edges of the optics, and this will degrade the image resolution.

We hope the following advice is helpful to you in setting up your new March scope.



Mounting your new March Scope

Preferred Rings and Bases

March recommends a one piece base such as a picatinny mount or a Stolle type benchrest rail. A one piece mount removes many of the alignment problems commonly seen in two piece mounting systems.

If a one piece base is not an option with your rifle, then that should not be a serious problem. We recommend that whenever scope rings are installed on a rifle, their alignment needs to be checked before a scope is mounted.

The best way to do this is to use a precision 30mm ring (or 34mm for the March-X and March-FX models) alignment tool. Some lapping of the scope rings may be required to bring the scope rings into alignment. However, if a scope is mounted in rings that are out of alignment then damage to your new March scope could occur or potentially unreliable performance. Your March Scope dealer can advise on some proper tools to assist you mount your scope in the rings.

Position the scope rings so they do not sit too near the extreme ends of the scope or even too close together and use a torque wrench to tighten the scope ring screws. Positioning the rings at the extreme end of the scope body could also cause damage to your new March. Check manufacturers specifications for torque value. Usually 15-20 in-lbs but will vary depending on Alloy or Steel.

Setting the Eye Relief

With the bolt removed from the unloaded rifle, aim the rifle in your usual shooting position. Very slowly move your March scope until you can see the full field of view. No dark circles at the edges should be present at this stage, and there will be a comfortable eye relief.

Make sure that you set enough eye relief position of your scope to prevent injury from recoil. Setting your new scope with incorrect eye relief and improper mounting can cause physical damage to the shooter.

Leveling the Reticle

It is very important for the vertical reticle to be level with the center of your rifle's bore. If this is not the case, canting of the rifle will occur and this will cause accuracy problems at long range.

One of the easiest ways to check vertical alignment is to use a vertical string line for example at about 10m in front of your rifle. Making sure your rifle is completely level, look through your March scope and confirm the vertical reticle is in line with the vertical string line.

At this point, use a torque wrench to tighten the scope ring screws.

Be sure to not over tighten the screws as this could also cause damage to your new March. Check that the scope has not moved as the screws are tightened.

Focus the Reticle

With your March scope securely installed on your rifle, it is now time to focus the reticle to your eyes.

With your scope at its lowest power setting, rotate the eyepiece counter-clockwise (when viewed from a normal shooting position) until the eyepiece moves freely. Looking through scope, aim at plain background such as the blue sky or a sheet of white paper.



DO NOT ATTEMPT TO LOOK AT THE SUN, AS PERMANENT EYE DAMAGE WILL RESULT.

When you turn the eyepiece, the reticle's clarity will change as the focal length changes. When the reticle is focused for your eyes, turn the locking ring counter-clockwise until it is firm against the eyepiece.

Do not attempt to over tighten but it must be firm.

Eyepiece Adjustment Line

(Zoom Scopes except EP-Zoom)

The factory setting of the eyepiece is at -0.5 diopter. It is indicated with white line.

The adjustment to suit normal eyesight should not be too far from this position.

Once the eyepiece is set at the best position for your eyes, it isn't necessary to alter the setting often unless changing of visual acuity or user.

Rotate eyepiece lock ring and align it on the white line to set back to factory setting of the eyepiece.

The factory setting of the eyepiece is indicated with white line.



Sighting in your March Rifle Scope

The easiest way to sight in your March scope is to bore sight your rifle against a target located between for example 25 and 50 meters away.

Bore sighting is easy. With your rifle securely rested and the bolt removed, look through the bore and move the rifle until you can see the target centered in the bore.

Without moving the rifle, look through the scope and adjust the windage and elevation setting to adjust the scope's reticle to the center of the target.

Fire a shot at the target and adjust the windage and elevation settings to move the reticle to the bullet's point of impact.

Turning the elevation dial towards "UP" moves the Point of Aim (POA) higher, while turning the dial towards "DN" moves the POA lower. Turning the windage dial towards "R" moves the POA to the right, while turning it to "L" moves the POA to the left.

After you have adjusted your scope to the point of impact, move the reticle back to the center of the target and fire another shot.

Repeat the adjustments to the windage and elevation dials until the point of aim meets the point of impact.

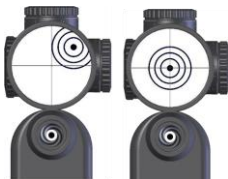

Important note:

Please check where your dials settings are after you have zeroed your rifle to the point of aim. The farther away the adjustments are from the central position (elevation and windage) the more optical resolution will degrade. Also you will not have available full amount of elevation or windage in one direction. So if your scope adjustment is set a long way off center to get the rifle zeroed this will indicate the alignment of the rifle bore is not at the same axis of the scope mount or base position.

Focus/Parallax adjustment

Your March Rifle Scope has a side focus dial that can be used to focus the scope on targets from approximately 10 yards to infinity.

The number on the dial is not an absolute reflection of the actual distance as this is affected by the user's eyesight and changing environmental factors.

It is critical, particularly for target shooting, that the setting be absolutely parallax free.

This means there should be no movement of the reticle relative to the target. To check this, move your head very slightly upwards and down or left to right and see that the reticle position does not move on the target. Be careful not to accidentally move your rifle when checking this.

The reticle should remain in the exact position aimed on the target as you slightly move your head position for parallax free operation. Adjust the focus dial until parallax free. If parallax movement is not completely removed you will have larger than usual grouping dispersion of your shots.



Side Focus dial



Side Focus Dial
Illumination Model

If the focus dial or zoom ring is stiff.

The side focus dial and zoom ring may be stiff to rotate due to lack of use or during cold weather. This is due to a settling of the lubricant on the airtight seals over time, or an increased viscosity in the lubricant at lower temperatures. Gently turning the dial back and forth will restore normal function.

Setting Elevation and Windage Zero

10x-60x52, 5x-50x56, 8x-80x56 , 10x-60x56HM Models

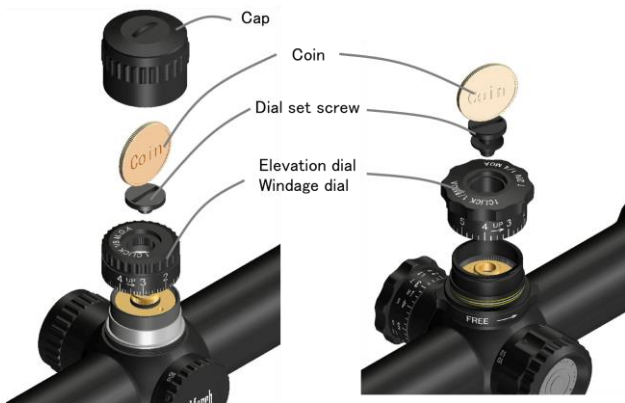

Remove the cap covering the windage or elevation dial (if equipped).

Turn the cap upside down; align the ridge on the cap with the grooved Dial Set Screw. Hold the dial tightly to prevent it from moving and unscrew the Dial Set Screw.

The dial can now be removed to expose the adjusting shaft and the windage or elevation scale. The dial can be replaced in the user's chosen position.

Replace the Dial Set Screw and hold the dial while tightening. Do not over tighten this screw.

1x-4x24, 1x-10x24, 2.5x-25x42 model

Remove the cap covering the windage or elevation dial (if equipped). Loosen the three set screws using the Allen wrench provided (see picture).

Once loose, the dial is free to turn and can be adjusted to any position required.

Retighten the three set screws once the dial's position is set; but do not over tighten.



Zero Set Function

10x-60x52, 5x-50x56, 8x-80x56, 10x-60x56HM Models

With a zero point established on the elevation dial, the Zero Set (marked "0-SET" on the scope) dial can be used to make sure you never lose this point.

Simply loosen the two 0-SET screws using the included Allen wrench and turn the 0-SET dial in the direction indicated by the 0-SET arrow to lock against the elevation dial.

Once in the desired position, lightly retighten the two set screw.

We recommended backing the setting off slightly to prevent any accidental binding.

If you do not need to use the Zero Set function, loosen the set screws and turn the dial counter-clockwise and leave it at the lowest position on the dial. Remember to lightly tighten the two set screws.



1x-10x24, 2.5x-25x42 model

The March compact model takes a different approach to the Zero Set. After setting the elevation dial to the desired position, hold the dial with your fingers and turn the “0-SET” Dial clockwise using a coin or correctly sized screw driver until the bottom stop is reached.

At this point the elevation cannot be lowered, so you will never lose your starting point.

If you do not need to use the Zero Set function, turn the “0-SET” dial counter-clockwise until it reaches the top of its travel.



Rubber Tactile switch

Illuminating the Reticle

The Illumination Module (where fitted) on March scopes produces four levels of light intensity on the reticle for precision shooting in low light or night conditions. Pushing the rubber switch on the focus dial activates the Illumination mode.

The Illumination Module cycles through OFF-1-2-3-4-OFF each time the switch is pressed.

The 4 setting is the brightest. The Illumination Module will automatically switch off after one hour to conserve battery life.

Changing the battery in the Illumination Module

Turn the switch counter-clockwise to expose the battery compartment. Replace the battery with a lithium CR2032 battery. Pay special attention to the battery polarity: the positive (+) side of the battery must face the scope body.



Using the Zoom to change magnification

Turn the zoom ring clockwise to increase your scope's magnification and counter-clockwise to decrease magnification.

Use the index point to select the most appropriate setting.



Modifier Disk

35mm MD Disk(Standard Option for Fixed Power Scopes, EP-Zoom, 10-60x52 Models)

43mm MD Disk(Extra-cost Option for 56mm Models)

The Modifier Disk does not use any lenses. It is a lightweight aluminum disk with a smaller diameter hole in it to reduce the amount of light entering the scope.

The Modifier Disk screws onto the scope via the threads in front of the objective lens.

Using Modifier Disk with your March scope will:

a; reduce the amount of light entering the scope by as much as 50%(35mmMD disk), 40%(43mm MD disk).

(depending on the brightness of the conditions)

b; increase the depth of focus by up to 50%(35mm MD disk), 40%(43mmMD disk).

If unnecessary brightness is reduced and the focus depth increased, a user's ability in reading mirage is enhanced as the sight picture is more defined in difficult conditions.

For light reduction purposes, it is possible to use a camera filter on the eyepiece

($\text{\O} = 37\text{mm}$, $P = 0.75$).

March recommends against using a filter on the objective lens because this affects target resolution.



March™ Flip Cap



a) Slide the correctly sized flip cap onto the eyepiece or objective end of the scope until it meets the inner edge of the cap. If the flip cap is difficult to install due to stiffness, warm it up first (only warm it slightly, do not apply direct heat).

b) After flipping the cap open, push the cap down until it locks into the open position. Make sure to lock the cap open when using the scope.

c) While flip caps protect against rain and dust, they are not waterproof. All March scopes are waterproof.

Parts No.	Item	Model
FC-41	41mm Flip cap for eyepiece	Eye-piece
FC-33	33mm Flip cap for 24mm objective	1x-4x24, 1x-4.5x24, 1x-8x24, 1x-10x24
FC-51	51mm Flip cap for 42mm objective	2.5x-25x42, 3x-24x42
FC-60	60mm Flip cap for 52mm objective	2.5x-25x52, 3x-24x52, 10x-60x52
FC-64	64mm Flip cap for 56mm objective	5x-40x56, 5x-50x56, 8x-80x56, 10x-60x56

Leather caps (Eyepiece and Objective)

Standard Option for Fixed Power Scopes
and EP-Zoom Scopes



Fast Lever

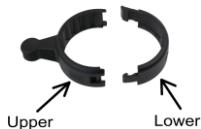

Wider nails



a) Firstly set the upper part of Fast Lever (with knob) on the scope magnification zoom ring.

Set the wider nails toward left. Set the lever knob right on the scope zoom ring knob. Make sure if the lever can fit on the scope zoom ring properly.



b) Next set the lower part of lever on the scope zoom ring.

Set the small hook of the lower part onto the windage side hook of the upper part.

Then set the bigger hook of the lower part onto the other side of the upper part until it clicks into place. It will be all set when the lever can fit and cover on the scope zoom ring completely.



How to remove the lever?

Once unhook the bigger hook of the lower part, all parts can be removed easily.

Manufacturing a March

Lens Design

March Rifle Scopes (except 1x-4x24, 1x-4.5x24, 1x-8x24 and 1x-10x24) use multi-coated Extra-low Dispersion (ED) lenses to reduce chromatic aberration and to provide high image resolution even at maximum magnification.

ED lenses have a smaller refractive index than typical optical lenses in the blue to red wavelength. This produces superior sharpness and color correction. ED lenses are often used in microscopes, high-end telescopes and semiconductors. ED lenses make it possible to maintain a consistent, high quality image from the lowest to highest magnification settings in your new March scope.

Internal Construction

March Rifle Scopes are made from specially heat-treated, high-grade aluminum, special alloy steel and brass. The scope body is filled with argon gas to create a stable environment. To ensure that March Scopes remain airtight, each scope is fitted with high performance, industrial grade rubber O-rings.

Second Focal Plane design

A reticle placed in the second focal plane will appear to stay the same size across the zoom range while the target changes size. This means that the marks in the reticle will change value across the zoom range. The specific reticles sizes are calculated at set magnifications and these should be used as reference marks to determine measurements at set ranges.

To determine what measurements are covered by your March's reticle, please refer to the reticle information contained at the end of this manual.

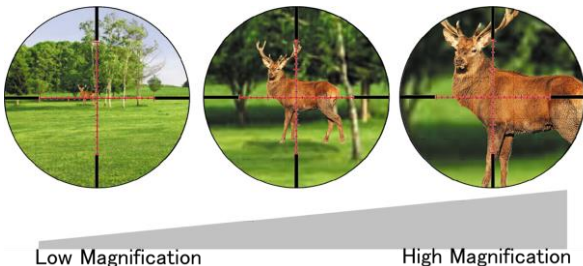

March

Fixed Power (48x52mm) High Master
EP Zoom (40x-60x52mm) High Master



High Master optical design

The High Master has Super ED lens with High refractive glass which offers very high resolution and natural color right to the edge of the image.

Windage and elevation markings

The windage/elevation dials are divided into 80 divisions, indicated by vertical white lines. Each division is 1/8 MOA. One full rotation of the dial is equal to 10 MOA. There are numbers (0-9) that appear above the division on the dial.

Comparing the dial to the windage/elevation scale below it, you can determine the amount of adjustment needed during sighting in.

Windage/Elevation travel is 60 MOA.

The farther away the adjustments are from the central position (elevation and windage), the more optical resolution will degrade.

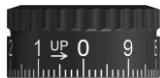

Elevation dial



Windage dial

Eyepiece Zoom (40x-60x52mm) High Master

The Eyepiece (EP) Zoom scope incorporates a specially designed device into the March 48x52 BR High Master scope to eliminate any mechanically induced Point of Aim shift during magnification changes.



How to adjust the reticle focus

While holding the eyepiece, rotate it counter-clockwise (from the shooter's perspective) until the eyepiece can move freely.

When looking through the scope, aim at either the sky or a sheet of white paper.

DO NOT ATTEMPT TO LOOK AT THE SUN, AS PERMANENT EYE DAMAGE WILL RESULT.

When you rotate the eyepiece, the reticle's clarity will change as the focal length changes. When the reticle is focused for your eyes, turn the locking ring counter-clockwise until it is firm against the eyepiece.

Do not attempt to over tighten.

How to adjust the zoom setting

When the roulette is all the way in, the scope is at the maximum power of 60x. To reduce the magnification, hold the eyepiece with your left hand (if you are right handed) and gently use your right hand to pull the roulette to the rear while turning it counter-clockwise. Pull until the index point is aligned with your desired power setting.

If the roulette becomes stiff

The roulette may become stiff to move due to lack of use or cold weather. This is due to a settling of the lubricant on the airtight seals over time, or an increased viscosity in the lubricant at lower temperatures. Setting the roulette between 45x and 55x when storing the scope will allow enough room to move the roulette either way if it ever becomes stiff to rotate.



March Compact zoom 1x-4x24mm 100yard Parallax Fixed



D4V24IML (Normal Turrets, Illuminated, MIL)

The 17.8 mm exit pupil at 1x enables the user to concentrate faster on the target.

March 1x-4x24mm is suitable for short and middle range hunting with simple features.

This scope is an excellent choice for short and middle range quarry, including moving targets. It is suitable for the harshest of environments.

The FD-1 reticle has a bright dot even in daytime on the center of 3-Post with four power setting illumination module.



Standard model
Elevation dial



Standard model
Windage dial

Adjustment

1 Click Adjustment: 0.1 MIL
(1cm at 100m)

10 MIL turret revolution (100cm
at 100m).

Elevation Travel: 56 MIL

Windage Travel: 56 MIL

Reticle

FD-1 reticle

Center Dot Illuminated Reticle

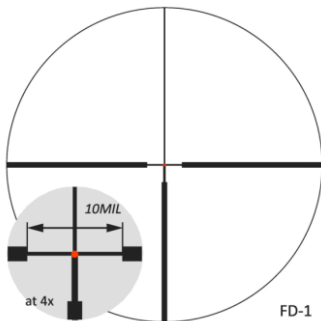

March

Compact zoom 1x-4.5x24mm



D4.5V24TM (Tactical Turrets)

Exit pupil 16mm at 1x

1x-4.5x24mm scope designed for Service Rifle competition and tactical applications.

This scope should set the standard for AR-friendly 4.5x optics. This compact variable-power scope offers ideal eye relief for AR-type rifles, along with plenty of windage and elevation travel.

Side focus dial lets you see the target clearly from 10 yards to Infinity at all power settings.



Tactical model
Elevation dial



Tactical model
Windage dial

Adjustment

1 Click Adjustment: 1/4 MOA

(0.26in at 100yds)

25 MOA turret revolution

(10.47in at 100yds).

Elevation Travel: 200 MOA

Windage Travel: 200 MOA

Reticle

MTR-D2 reticle

Center Dot Reticle

1/2 MOA Dot at 4.5x

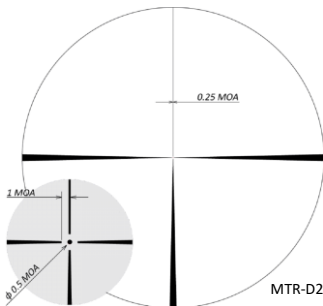

Reticle
MTR-D3 reticle

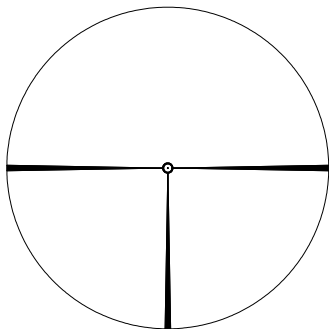

Enlarged view of center

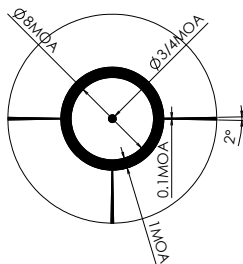

MTR-D3 reticle
At 4.5x

Reticle
MTR-5 reticle
Center Dot Reticle
1.1 MOA Dot at 4.5x

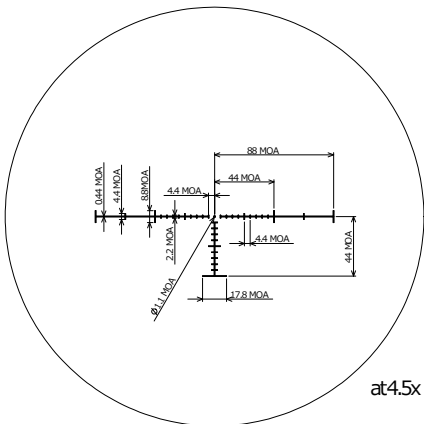
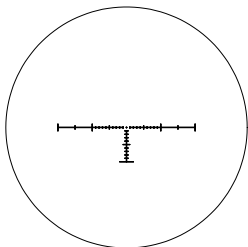

at 4.5x

March **Compact zoom (1x-10x24mm, 2.5x-25x42mm)**



Windage and elevation markings

The windage/elevation dials are divided into 100 divisions, indicated by vertical white lines.

MOA Models

(Normal and Tactical)

Each division is 1/4 MOA.

One full rotation of the dial is equal to 25 MOA. These are printed on the dial to assist the user with changing sight settings.



Standard model
Elevation dial



Standard model
Windage dial



Tactical model
Elevation dial



Tactical model
Windage dial

1-10x24: The windage/elevation adjustment; 200 MOA.

2.5-25x42: The windage/elevation adjustment; 100 MOA.

Mil-radian Models (Tactical only)

Each division is 0.1 Mil.

One full rotation of the dial is equal to 10 Mil. These are printed on the dial to assist the user with changing sight settings.



Mil model
Elevation dial



Mil model
Windage dial

1-10x24: The windage/elevation adjustment; 56 Mil.

2.5-25x42: The windage/elevation adjustment; 28 Mil..

March Compact zoom (1.5x-15x42mm)



Windage and elevation markings

The windage/elevation dials are divided into 80 divisions, indicated by vertical white lines.

MOA Models (Tactical dial)

Each division is 1/4 MOA.

One full rotation of the dial is equal to 20 MOA.

These are printed on the dial to assist the user with changing sight settings.

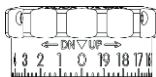

Elevation dial



Windage dial



The Elevation adjustment; 80 MOA.

The Windage adjustment; 50 MOA.

The suggested range of elevation adjustment is a total of 80MOA. Each rotation represents 20MOA of elevation adjustment and the elevation turret can be rotated 2 turns (20MOA/rotation) each way from the middle for a total of 40MOA up and 40MOA down.

Please be aware that the elevation turret can be rotated more than 4 rotations (2 up and 2 down), however when the turrets are rotated beyond ± 40 MOA from the middle position, you may experience some image quality degradation.

In order to indicate that the knob have been turned beyond the 40MOA up or down, the third turn will be indicated by a red line appearing on the elevation turret to show that you have exceeded the usable range. Please note that turning more than 2 rotations from the middle setting up or down, will not damage the riflescope in any way but the image quality may suffer some degradation.

Zero Set Function

The March 1.5x-15x42 model takes a different approach to the Zero Set. After setting the elevation dial to the desired position, hold the dial with your fingers and turn the “0-SET” Dial counter-clockwise using a coin or correctly sized screw driver until the bottom stop is reached.

At this point the elevation cannot be lowered so that you will not lose your starting point.

If you do not need to use the Zero Set function, turn the “0-SET” dial clockwise until it reaches the top of its travel.



Fast Focus Eyepiece

This Fast Focus Eyepiece is capable of adjusting ± 2 diopter in a single turn. Hence this enables prompt adjustment for the Eyepiece. Fast pitch eyepiece setting comes in handy when the time is the essence.



MIL Models

(Normal dial)

Each division is 0.1MIL. One full rotation of the dial is equal to 10MIL.

The Elevation adjustment; 40MIL.

The Windage adjustment; 40MIL



March 52mm Compact zoom (2.5x-25x52mm)



Windage and elevation markings

The windage/elevation dials are divided into 100 divisions, indicated by vertical white lines.

MOA Models

(Normal and Tactical)

Each division is 1/4 MOA.

One full rotation of the dial is equal to 25 MOA. These are printed on the dial to assist the user with changing sight settings.

The windage adjustment; 120 MOA.

The elevation adjustment; 60 MOA.



Tactical model
Elevation dial



Tactical model
Windage dial

Mil-radian Models (Tactical only)

Each division is 0.1 Mil.

One full rotation of the dial is equal to 10 Mil. These are printed on the dial to assist the user with changing sight settings.

The windage adjustment; 34 Mil.

The elevation adjustment; 17 Mil.



Mil model
Elevation dial

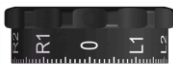

Mil model
Windage dial

March Variable Power (10x-60x52mm)



Windage and elevation markings

The windage/elevation dials are divided into 80 divisions, indicated by vertical white lines. The Tactical Model has 40 divisions.

Normal Models (-L, LM)

Each division is 1/8 MOA.

One full rotation of the dial is equal to 10 MOA. These are printed on the dial to assist the user with changing sight settings.



Standard model
Elevation dial



Standard model
Windage dial

Tactical Models (-T, TM, TI)

Each division is 1/4 MOA with two (2) clicks per division (1/8 MOA clicks).

One full rotation of the dial is equal to 10 MOA. These are printed on the dial to assist the user with changing sight settings.



Tactical model
Elevation dial



Tactical model
Windage dial

The elevation adjustment; 60 MOA.

The windage adjustment; 40 MOA.

March-X Variable Power (10x-60x56mm) High Master



High Master optical design

The High Master has Super ED lens with High refractive glass which offers very high resolution and natural color right to the edge of the image.

Windage and elevation markings

The windage/elevation dials are divided into 80 divisions, indicated by vertical white lines. The Tactical Model has 40 divisions.

Normal Models (-L, LM)

Each division is 1/8 MOA.

One full rotation of the dial is equal to 10 MOA. These are printed on the dial to assist the user with changing sight settings.



Standard model
Elevation dial



Standard model
Windage dial

Tactical Models (-T, TM, TI)

Each division is 1/4 MOA with two (2) clicks per division (1/8 MOA clicks).

One full rotation of the dial is equal to 10 MOA. These are printed on the dial to assist the user with changing sight settings.

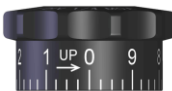

Tactical model
Elevation dial



Tactical model
Windage dial

The elevation adjustment; 60 MOA.

The windage adjustment; 40 MOA.

March-X

High Magnification Zoom (5x-50x56mm, 8x-80x56mm)

Note: March-X rifle scopes require 34mm scope rings



Windage and elevation markings

The windage/elevation dials are divided into 40 divisions, indicated by vertical white lines.



Tactical model
Elevation dial



Tactical model
Windage dial

Each division is 1/4 MOA

with two (2) clicks per division (1/8 MOA clicks).

One full rotation of the dial is equal to 10 MOA. These are printed on the dial to assist the user with changing sight settings.

The elevation adjustment; 60 MOA.

The windage adjustment; 40 MOA.



Fixed power Scope and EP zoom Riflescope			
SPECIFICATIONS			
		48x52	EP-Zoom
Model No.		D48F52	D60EV52
Magnification	Low	48x	40x
	High	-	60x
Effective Lens Diameter		52mm	
Exit Pupil	Low	1.08mm	1.24mm
	High	-	0.89mm
Field of View real	Low	Degree	0.52°
		ft/100Yd	2.7ft
		m/100m	0.90m
	High	Degree	-
		ft/100Yd	-
		m/100m	-
Eye Relief	Low	66-81mm	71-89mm
	High	-	59-72mm
1 Click Value		1/8MOA	
1 Turn travel		10MOA	
Elevation Travel		60MOA	
Windage Travel		60MOA	
Focus		Side Focus/Parallax	
Distance		10yd-Infinity	
Finish		Matte Black	
Illumination		-	
Reticle		CH, 1/8MOA Dot, 3/32MOA Dot, 1/16MOA Dot, LR	
Body Tube Diameter		30mm	
Weight		645g (22.8oz)	690g (24.3oz)

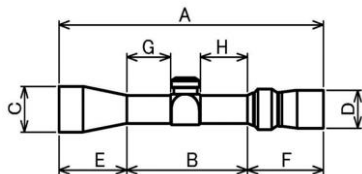

	D48F52	EP-Zoom
A	370mm (14.6inch)	374-397mm
B	177mm (7.0inch)	162mm (6.4inch)
C	60mm (2.4inch)	60mm (2.4inch)
D	41mm (1.6inch)	41mm (1.6inch)
E	126mm (5.0inch)	126mm (5.0inch)
F	67mm (2.6inch)	86-109mm
G	70mm (2.8inch)	70mm (2.8inch)
H	70mm (2.8inch)	55mm (2.2inch)



Compact zoom 1x-4x24mm Riflescope			
SPECIFICATIONS			
Model No.		D4V241ML	
Magnification	Low	1x	
	High	4x	
Effective Lens Diameter		24mm	
Exit Pupil	Low	17.8mm	
	High	6mm	
Field of View real	Degree	Low	19°
		High	4.7°
	ft/Yd	Low	100.4ft/100Yd (33.47m/100m)
		High	24.9ft/100Yd (8.20m/100m)
Eye Relief	Low	64-96mm	
	High	61-94mm	
1 Click Value		0.1MIL	
1 Turn travel		10MIL	
Elevation Travel		56MIL	
Windage Travel		56MIL	
Focus		No	
Distance		100Yd	
Finish		Matte Black	
Illumination		Yes	
Reticle		FD-1	
Body Tube Diameter		30mm	
Weight	g	520	
	oz	18.3	

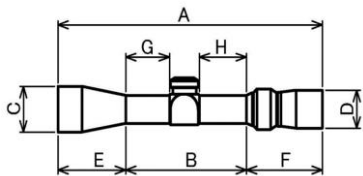

	1x-4x24
A	258mm(10.2inch)
B	129mm(5.1inch)
C	33mm(1.3inch)
D	41mm(1.6inch)
E	35mm(1.4inch)
F	94mm(3.7inch)
G	49mm(1.9inch)
H	42mm(1.7inch)



Compact zoom 1x-4.5x24mm Rifle Scope			
SPECIFICATIONS			
Model No.		D4.5V24TM	
Magnification	Low	1x	
	High	4.5x	
Effective Lens Diameter		24mm	
Exit Pupil	Low	16mm	
	High	5.33mm	
Field of View real	Degree	Low	19°
		High	4.22°
	ft/Yd	Low	100.4ft/100Yd (33.47m/100m)
		High	22.12ft/100Yd (7.37m/100m)
Eye Relief	Low	73-103mm	
	High	73-103mm	
1 Click Value		1/4MOA	
1 Turn travel		25MOA	
Elevation Travel		200MOA	
Windage Travel		200MOA	
Focus		Side Focus	
Distance		10yd-infinity	
Finish		Matte Black	
Illumination		No	
Reticle		MTR-D2, MTR-D3, MTR-5	
Body Tube Diameter		30mm	
Weight	g	530	
	oz	18.7	

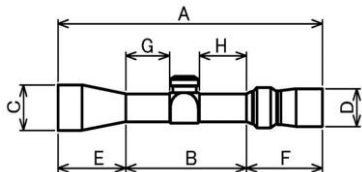

	1x-4.5x24
A	260mm(10.2inch)
B	131mm(5.2inch)
C	33mm(1.3inch)
D	41mm(1.6inch)
E	35mm(1.4inch)
F	94mm(3.7inch)
G	49mm(1.9inch)
H	46mm(1.8inch)



Compact zoom 1x-10x24mm Riflescope									
SPECIFICATIONS									
Model No.		D10V24	D10V24M	D10V24T	D10V24TM	D10V24TI	D10V24TML	D10V24TML	
Magnification	Low	1x							
	High	10x							
Effective Lens Diameter		24mm							
Exit Pupil		High 2.4mm							
Field of View real	Degree	Low 20°							
		High 2°							
	ft/Yd	Low 105.8ft/100Yd (35.27m/100m)							
		High 10.5ft/100Yd (3.49m/100m)							
Eye Relief		Low 86-98mm							
		High 86-96mm							
1 Click Value		1/4MOA					0.1Mil		
1 Turn travel		25MOA					10Mil		
Elevation Travel		200MOA					56Mil		
Windage Travel		200MOA					56Mil		
Focus		Side Focus/Parallax							
Distance		10yd-Infinity							
Finish		Matte Black							
Illumination		-				Yes	-	Yes	
Reticle		Di-plex	MTR-1 MTR-2 MTR-3 MTR-4	Di-plex	MTR-1 MTR-2 MTR-3 MTR-4	MTR-1 MTR-2 MTR-3 MTR-4 MTR-5	MML	MML	
Body Tube Diameter		30mm							
Weight		g	520	530	530	530	560	530	560
		oz	18.3	18.7	18.7	18.7	19.8	18.7	19.8

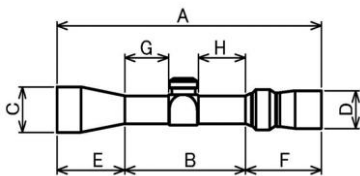

	1x-10x24
A	264mm(10.4inch)
B	135mm(5.3inch)
C	33mm(1.3inch)
D	41mm(1.6inch)
E	35mm(1.4inch)
F	94mm(3.7inch)
G	49mm(1.9inch)
H	48mm(1.9inch)



Compact zoom 1.5x-15x42mm Riflescope			
SPECIFICATIONS			
Model No.		D15V42TI	D15V42IML
Magnification	Low	1.5x	
	High	15x	
Effective Lens Diameter		42mm	
Exit Pupil	Low	8.7mm	
	High	2.8mm	
Field of View real	Degree	Low	13.3°
		High	1.33°
	ft/Yd	Low	70.2ft/100Yd (23.4m/100m)
		High	6.9ft/100Yd (2.3m/100m)
Eye Relief	Low	69-113mm	
	High	74-94mm	
1 Click Value		1/4MOA	0.1MIL
1 Turn travel		20MOA	10MIL
Elevation Travel		80MOA	40MIL
Windage Travel		50MOA	40MIL
Focus		Side Focus	
Distance		10yd-infinity	
Finish		Matte Black	
Illumination		Yes	
Reticle		MTR-3, MTR-4, MTR-5	FD-1, FD-2
Body Tube Diameter		30mm	
Weight	g	624g	
	oz	22.0oz	

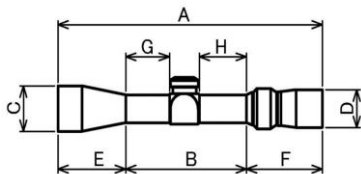

	1.5x-15x42
A	268mm(10.6inch)
B	111mm(4.4inch)
C	51mm(2.0inch)
D	41mm(1.6inch)
E	68mm(2.7inch)
F	89mm(3.5inch)
G	36mm(1.4inch)
H	37mm(1.5inch)



Compact zoom 2.5x-25x42mm Riflescope									
SPECIFICATIONS									
Model No.		D25V42	D25V42M	D25V42T	D25V42TM	D25V42TI	D25V42TML	D25V42TML	
Magnification		Low	2.5x						
		High	25x						
Effective Lens Diameter		42mm							
Exit Pupil		High	1.68mm						
Field of View real		Degree	Low	8°					
			High	0.8°					
		ft/Yd	Low	42ft/100Yd (13.99m/100m)					
			High	4.2ft/100Yd (1.40m/100m)					
Eye Relief		Low	85-100mm						
		High	89-96mm						
1 Click Value		1/4MOA				0.1Mil			
1 Turn travel		25MOA				10Mil			
Elevation Travel		100MOA				28Mil			
Windage Travel		100MOA				28Mil			
Focus		Side Focus/Parallax							
Distance		10yd-Infinity							
Finish		Matte Black							
Illumination		-				Yes	-	Yes	
Reticle		CH Di-plex	MTR-1 MTR-2 MTR-3 MTR-4	CH Di-plex	MTR-1 MTR-2 MTR-3 MTR-4 MTR-FT	MTR-1 MTR-2 MTR-3 MTR-4 MTR-5 MTR-FT	MML	MML	
Body Tube Diameter		30mm							
Weight		g	610	620	620	620	650	620	650
		oz	21.5	21.9	21.9	21.9	22.9	21.9	22.9

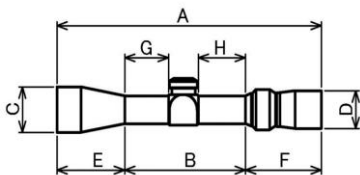

	2.5x-25x42
A	314mm(12.4inch)
B	139mm(5.5inch)
C	51mm(2.0inch)
D	41mm(1.6inch)
E	81mm(3.2inch)
F	94mm(3.7inch)
G	53mm(2.1inch)
H	48mm(1.9inch)



Compact zoom 2.5x-25x52mm Riflescope SPECIFICATIONS						
Model No.		D25V52T	D25V52TM	D25V52TI	D25V52TML	D25V52TML
Magnification	Low	2.5x				
	High	25x				
Effective Lens Diameter		52mm				
Exit Pupil		2.08mm				
Field of View real	Degree	Low				
		High				
	ft/Yd	Low				
		High				
Eye Relief		Low				
		High				
1 Click Value		1/4MOA			0.1Mil	
1 Turn travel		25MOA			10Mil	
Elevation Travel		120MOA			34Mil	
Windage Travel		60MOA			17Mil	
Focus		Side Focus/Parallax				
Distance		10yd-Infinity				
Finish		Matte Black				
Illumination		-		Yes	-	Yes
Reticle		CH Di-plex	MTR-1 MTR-2 MTR-3 MTR-4 MTR-5 MTR-FT	MTR-1 MTR-2 MTR-3 MTR-4 MTR-5 MTR-FT	MML	MML
Body Tube Diameter		30mm				
Weight	g	665	665	695	665	695
	oz	23.3	23.3	24.3	23.3	24.3

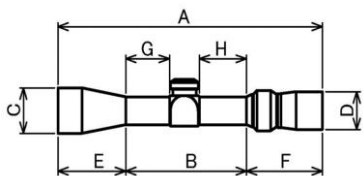

	2.5x-25x52
A	338mm(13.3inch)
B	139mm(5.5inch)
C	60mm(2.4inch)
D	41mm(1.6inch)
E	105mm(4.1inch)
F	94mm(3.7inch)
G	53mm(2.1inch)
H	48mm(1.9inch)



6x magnifications zoom Riflescope SPECIFICATIONS						
10x-60x52mm						
Model No.		D60V52L	D60V52LM	D60V52T	D60V52TM	D60V52TI
Magnification	Low	10x				
	High	60x				
Effective Lens Dia		52mm				
Exit Pupil		High				
		0.86mm				
Field of View real	Degree	Low				
		High				
	ft/Yd	Low				
		High				
		10.5ft/100Yd (3.49m/100m)				
		1.7ft/100Yd (0.58m/100m)				
Eye Relief		Low				
		High				
		88-99mm				
		95-101mm				
1 Click Value		1/8MOA				
1 Turn travel		10MOA				
Elevation Travel		60MOA				
Windage Travel		40MOA				
Focus		Side Focus/Parallax				
Distance		10yd-Infinity				
Finish		Matte Black				
Illumination		-				Yes
Reticle		CH	MTR-1	CH	MTR-1	MTR-1
		1/8	MTR-2	1/8	MTR-2	MTR-2
		3/32	MTR-3	3/32	MTR-3	MTR-3
		1/16	MTR-4	1/16	MTR-4	MTR-4
		Di-plex	MTR-FT	Di-plex	MTR-FT	MTR-5
						MTR-FT
Body Tube Diameter		30mm				
Weight	g	700	710	720	730	760
	oz	24.7	25.0	25.4	25.7	26.8

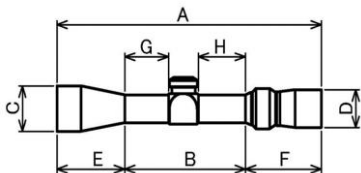

	10x-60x52
A	420mm (16.5inch)
B	173mm (6.8inch)
C	60mm (2.4inch)
D	41mm (1.6inch)
E	142mm (5.6inch)
F	105mm (4.1inch)
G	79mm (3.1inch)
H	57mm (2.2inch)



6x magnifications zoom Riflescope SPECIFICATIONS					
10x-60x56mm High Master					
Model No.	D60HV56L	D60HV56LM	D60HV56T	D60HV56TM	D60HV56TI
Magnification	Low	10x			
	High	60x			
Effective Lens Dia	56mm				
Exit Pupil	High	0.94mm			
Field of View real	Degree	Low	1.9°		
		High	0.32°		
	ft/Yd	Low	10.2ft/100Yd (3.40m/100m)		
		High	1.7ft/100Yd (0.57m/100m)		
Eye Relief	Low	80-107mm			
	High	92-102mm			
1 Click Value	1/8MOA				
1 Turn travel	10MOA				
Elevation Travel	60MOA				
Windage Travel	40MOA				
Focus	Side Focus/Parallax				
Distance	10yd-Infinity				
Finish	Matte Black				
Illumination	-				Yes
Reticle	CH	MTR-1	CH	MTR-1	MTR-1
	1/8	MTR-2	1/8	MTR-2	MTR-2
	3/32	MTR-3	3/32	MTR-3	MTR-3
	1/16	MTR-4	1/16	MTR-4	MTR-4
	Di-plex	MTR-FT	Di-plex	MTR-FT	MTR-5 MTR-FT
Body Tube Diameter	34mm				
Weight	g	905	915	925	960
	oz	32.0	32.3	32.6	33.8

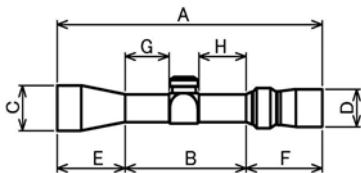

	10x-60x56
A	413mm(16.3inch)
B	180mm(7.1inch)
C	64mm(2.5inch)
D	41mm(1.6inch)
E	134mm(5.3inch)
F	99mm(3.9inch)
G	81mm(3.2inch)
H	63mm(2.5inch)



High magnification Zoom Rifle scope SPECIFICATIONS										
		5x-50x56mm			8x-80x56mm					
Model No.		D50V56T	D50V6TM	D50V56TI	D80V56T	D80V56TM	D80V56TI	D80V56ST	D80V56STM	D80V56STI
Magnification	Low	5x			8x					
	High	50x			80x					
Effective Lens Diameter		56mm								
Exit Pupil		High 1.12mm			0.7mm					
Field of View	Degree	Low 4.0°			2.5°					
		High 0.4°			0.25°					
real	ft/Yd	Low 21ft/100Yd (6.98m/100m)			13.2ft/100Yd (4.36m/100m)					
		High 2.1ft/100Yd(0.70m/100m)			1.3ft/100Yd (0.44m/100m)					
Eye Relief		Low 96-101mm			89-95mm					
		High 92-98mm			83-97mm					
1 Click Value		1/8MOA								
1 Turn travel		10MOA								
Elevation Travel		60MOA								
Windage Travel		40MOA								
Focus		Side focus								
Distance		10yd-Infinity								
Finish		Matte Black					Silver			
Illumination		-			Yes			-		Yes
Reticle		CH 1/8Dot 3/32Dot 1/16Dot Di-plex	MTR-1 MTR-2 MTR-3 MTR-4 MTR-FT	MTR-1 MTR-2 MTR-3 MTR-4 MTR-5 MTR-FT	CH 1/8Dot 3/32Dot 1/16Dot Di-plex	MTR-1 MTR-2 MTR-3 MTR-4 MTR-FT	MTR-1 MTR-2 MTR-3 MTR-4 MTR-5 MTR-FT	CH 1/8Dot 3/32Dot 1/16Dot Di-plex	MTR-1 MTR-2 MTR-3 MTR-4 MTR-FT	MTR-1 MTR-2 MTR-3 MTR-4 MTR-5 MTR-FT
Body Tube Diameter		34mm								
Weight	g	830	840	870	845	855	885	845	855	885
	oz	29.3	29.6	30.7	29.8	30.2	31.2	29.8	30.2	31.2

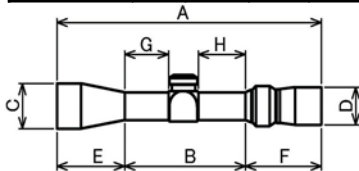

	5x-50x56	8x-80x56
A	400mm(15.7inch)	409mm(16.1inch)
B	166mm(6.5inch)	175mm(6.9inch)
C	64mm(2.5inch)	64mm(2.5inch)
D	41mm(1.6inch)	41mm(1.6inch)
E	144mm(5.7inch)	144mm(5.7inch)
F	90mm(3.5inch)	90mm(3.5inch)
G	79mm(3.1inch)	79mm(3.1inch)
H	51mm(2.0inch)	60mm(2.4inch)

Reticles

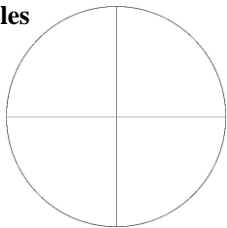

Crosshair reticle

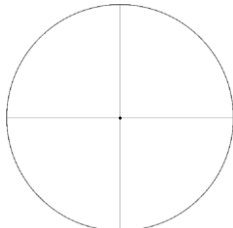

Crosshair with Dot reticle

1/16 MOA Dot
3/32 MOA Dot
1/8 MOA Dot

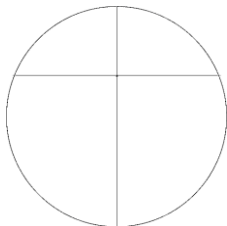

LR reticle (with 1/16Dot)

Standard mag. of Dot Reticle	
48x52	48x
EP-Zoom	48x
10x-60x52	40x
10x-60x56	40x
2.5x-25x42	25x
5x-50x56	40x
8x-80x56	40x

Magnification Power Changes and Dot Size

Dot pattern reticles (pictured above) do not change size as the magnification changes. But the size of the area on the target covered by the Dot will change.

Each March scope has a standard magnification where the apparent size of the Dot will match the reticle fitted to your scope.

For example, if you were using a 5-50x56 March scope fitted with a 1/8 MOA dot reticle at 20 power, you could use the following formula to determine how much of the target is covered by the Dot. Use the table to determine the Standard Magnification of Dot MOA for your model.

$(\text{Nominal Dot MOA}) \times (\text{Standard Magnification of Dot MOA}) / (\text{Current magnification}) = (\text{Current Dot MOA})$

$$(1/8 \text{ MOA}) \times (40 / 20) = 1/4 \text{ MOA}$$

The formula used above can also be used with other reticles that use hash marks or dots to determine target coverage or distance to the target.

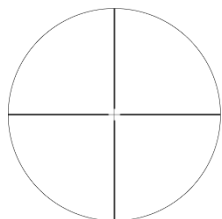

Di-plex reticle

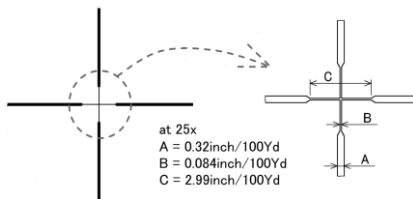

Di-plex reticle size

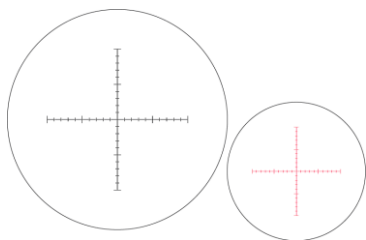

MTR-1

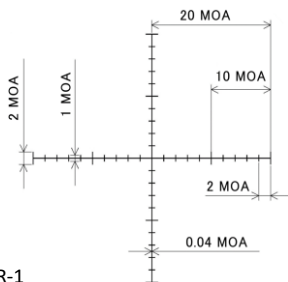

MTR-1
Reticle size at 20x

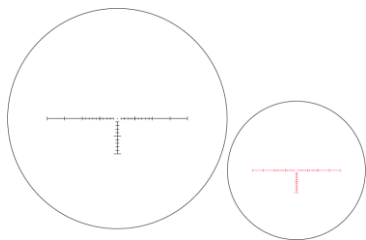

MTR-2

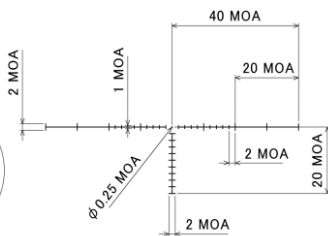

MTR-2
Reticle size at 10x

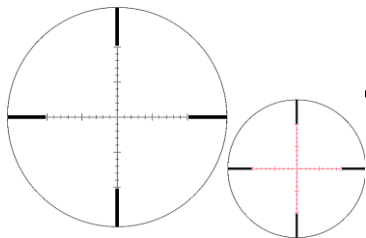

MTR-3

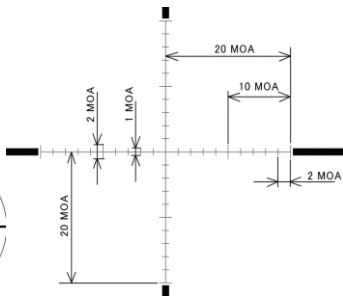

MTR-3 reticle size at 20x

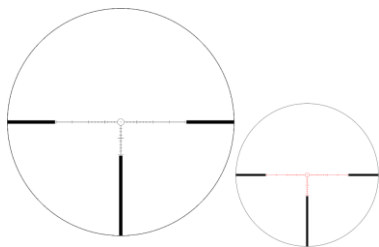

MTR-4

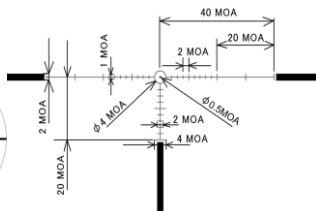

MTR-4 reticle size at 10x

The MTR-3 and MTR-4 reticles are twice as thick as the MTR-1 and MTR-2.

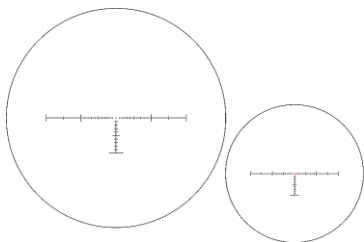

MTR-5

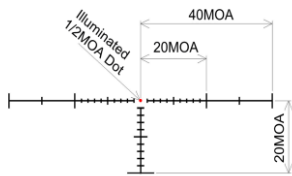

MTR-5 reticle size at 10x

MTR-1, MTR-3 Value of 1 division

	1div.	100yd	200yd	300yd	600yd	1,000yd
5X	8MOA	8.38 inch	16.75 inch	25.13 inch	50.26 inch	83.76 inch
8X	5MOA	5.24 inch	10.47 inch	15.71 inch	31.41 inch	52.35 inch
10X	4MOA	4.19 inch	8.38 inch	12.56 inch	25.13 inch	41.88 inch
15X	2.67MOA	2.79 inch	5.58 inch	8.38 inch	16.75 inch	27.92 inch
20X	2MOA	2.09 inch	4.19 inch	6.28 inch	12.56 inch	20.94 inch
25X	1.60MOA	1.68 inch	3.35 inch	5.03 inch	10.05 inch	16.75 inch
40X	1MOA	1.05 inch	2.09 inch	3.14 inch	6.28 inch	10.47 inch
50X	0.8MOA	0.84 inch	1.68 inch	2.51 inch	5.03 inch	8.38 inch
60X	0.67MOA	0.70 inch	1.40 inch	2.09 inch	4.19 inch	6.98 inch
80X	0.50MOA	0.52 inch	1.05 inch	1.57 inch	3.14 inch	5.24 inch

MTR-2, MTR-4, MTR-5 Value of 1 division

	1div.	100yd	200yd	300yd	600yd	1,000yd
5X	4MOA	4.19 inch	8.38 inch	12.56 inch	25.13 inch	41.88 inch
8X	2.5MOA	2.62 inch	5.24 inch	7.85 inch	15.71 inch	26.18 inch
10X	2MOA	2.09 inch	4.19 inch	6.28 inch	12.56 inch	20.94 inch
15X	1.33MOA	1.40 inch	2.79 inch	4.19 inch	8.38 inch	13.96 inch
20X	1MOA	1.05 inch	2.09 inch	3.14 inch	6.28 inch	10.47 inch
25X	0.8MOA	0.84 inch	1.68 inch	2.51 inch	5.03 inch	8.38 inch
40X	0.5MOA	0.52 inch	1.05 inch	1.57 inch	3.14 inch	5.24 inch
50X	0.4MOA	0.42 inch	0.84 inch	1.26 inch	2.51 inch	4.19 inch
60X	0.33MOA	0.35 inch	0.70 inch	1.05 inch	2.09 inch	3.49 inch
80X	0.25MOA	0.26 inch	0.52 inch	0.79 inch	1.57 inch	2.62 inch

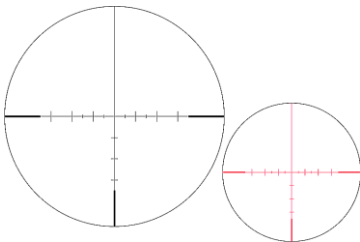

MTR-FT

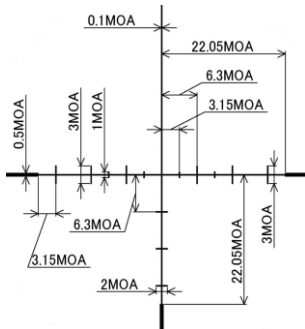

MTR-FT reticle size at 20x

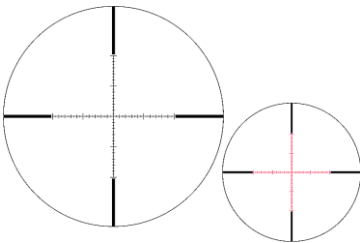

MML

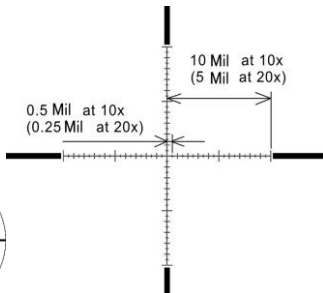

MML reticle size at 20x

Flash-Dot Reticle

The FD-1 & FD-2 reticles have a bright dot even in daytime on the center.

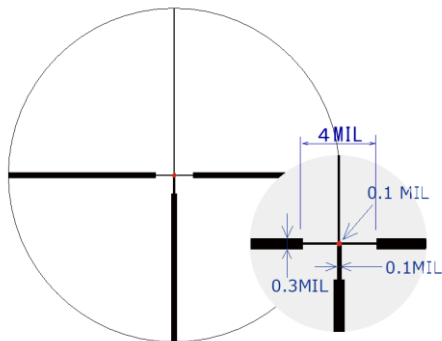

FD-1 at 10x

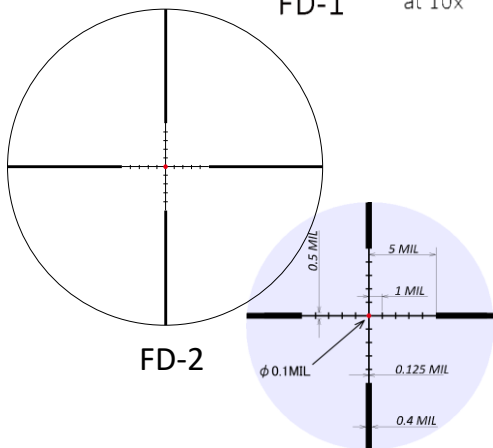

FD-2

at 10x

Caring for your March Rifle Scope

March Rifle Scopes are sealed units. However condensation may form on the outside of the lens under extreme conditions. Should this occur, dry with a soft lens cloth immediately and allow the lens to dry completely. Doing this will prevent water spots from developing on the lens surface.

March recommends that only quality lens cleaning material is used on the objective and eyepiece lenses to avoid scratching the glass.

Repair Services

Please retain and follow the Warranty paperwork in case your March Rifle Scope requires repair with the Warranty period. Please inquire of the dealer purchased from, and follow their repair request instruction. When returning your March Rifle Scope for repair, please enclose and provide a full description of the issue you are having on the form provided with your Warranty.

Should repairs be required outside Warranty period, please contact the dealer purchased from or Deon Optical Design Corporation before sending.

March[®]

Manufacturer

DEON

Deon Optical Design Corporation
4802-2 Miyagawa, Chino-shi,
Nagano-ken, 391-0013 Japan
E-mail: info@deon.co.jp
URL: <http://marchscopes.com>